

CHORUS

# MONO CHRO ME COL LEC TIONS

**GEWISS**



# MONO CHROME COLLECTIONS

Perfect harmony

Our **Monochrome collections** represent perfect harmony between plates and switches, between pure lines and timeless elegance. Neutral colours match the environment and follow the most contemporary decor and design trends. The choice between glossy and matte gives unexpected light effects and makes every living style unique.



# Styles and collections meet

With our **Monochrome collections**, Gewiss offers numerous aesthetic solutions for your home - **5 collections for 4 styles** - and guides you in choosing the one that best suits you.

Each **collection** is a combination of a finish and a colour. Each **style** represents the character of the home, which materialises in the design of each plate.

<b>COLLECTIONS</b>		<b>STYLES</b>
<b>FINISH</b>	<b>COLOUR</b>	
<ul style="list-style-type: none"> <li>▣ SATIN</li> <li>▣ GLOSSY</li> </ul>	<ul style="list-style-type: none"> <li>▣ WHITE</li> <li>▣ NATURAL BEIGE</li> <li>▣ BLACK</li> <li>▣ WHITE</li> <li>▣ TITANIUM</li> </ul>	<ul style="list-style-type: none"> <li>▣ ICE / ICE TOUCH</li> <li>▣ LUX</li> <li>▣ GEO</li> <li>▣ ONE</li> </ul>

STYLE

# ICE and ICE TOUCH

## Precious intelligence

Elegant, pure, evocative and perfect style



STYLE

# LUX

## Luxury before everything

Authentic, prestigious, exclusive and precious style

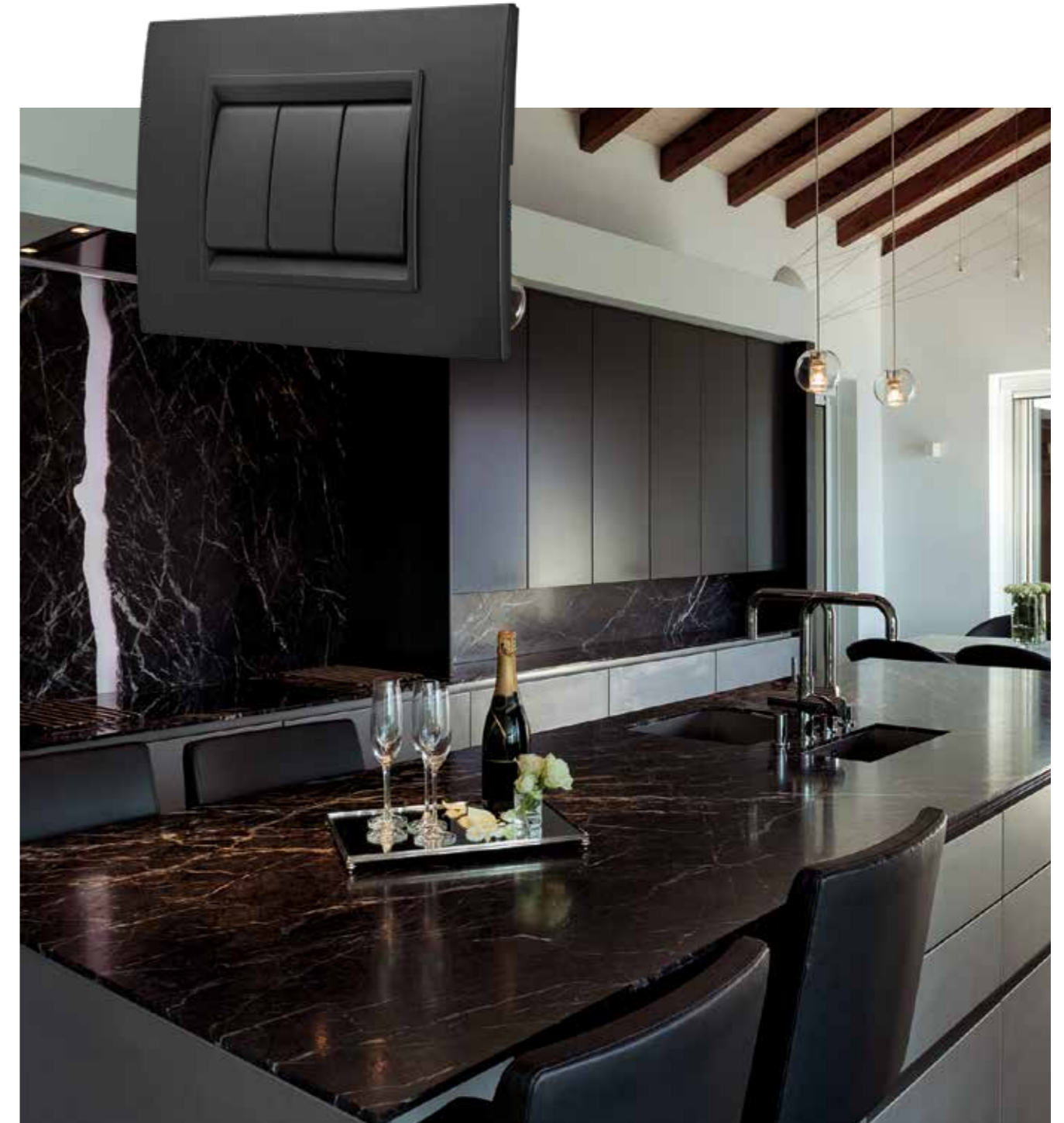

STYLE

# GEO

## Iconic character

Minimal, contemporary and easy style



STYLE

# ONE

## Young look

Soft, timeless, cosy and eclectic style



COLLECTION

# Satin White

White is **the synthesis of all colours**. A characteristic that enhances forms and honours every detail. Living styles have always proposed numerous variations of Total White. The **satin White collection from Monochrome** knows how to give a voice to each of these modulations, from the most decorative to the most classic, from the most minimal to the most modern.

ICE and ICE Touch plates are made of glass and are characterised by a glossy finish

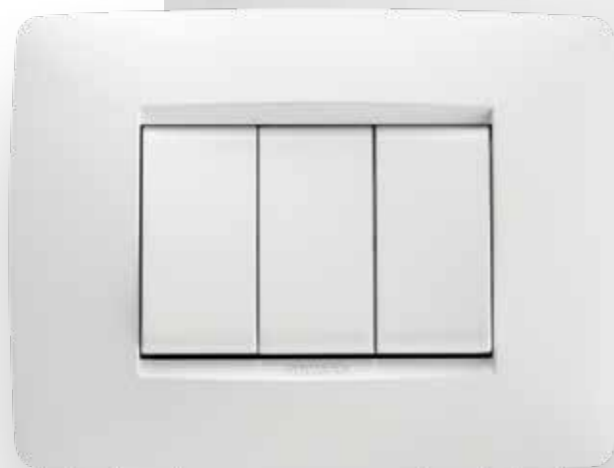

ONE

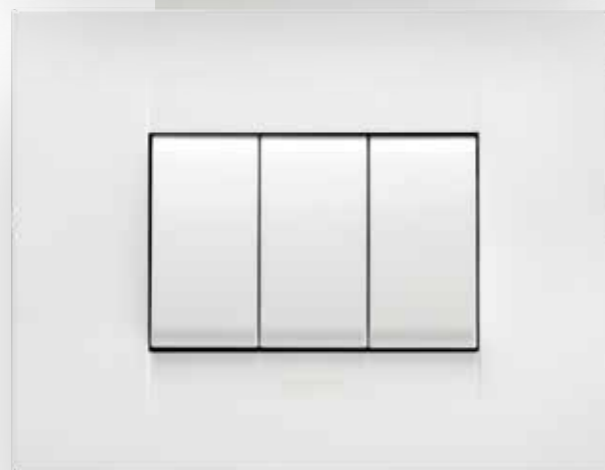

GEO



LUX

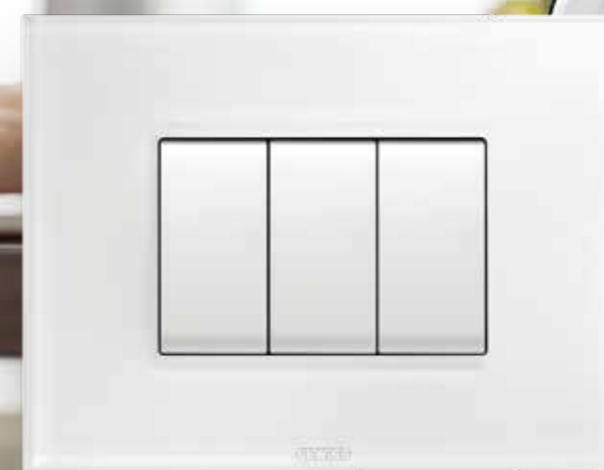

ICE



ICE TOUCH

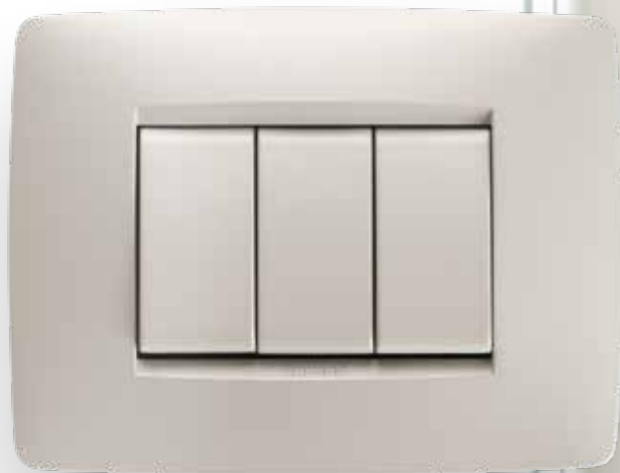

ONE



GEO



LUX



ICE



ICE TOUCH

COLLECTION

# Satin Natural beige

Beige adds warmth to the neutral tone range. **It warms, triggers emotions** and surprises with its proximity to the most natural materials. If you make the choice, rooms take on a refined and tactile atmosphere, with gentle contrasts and an interplay of lights. The nuances of the **satin Natural beige collection from Monochrome** make interior design truly exclusive, and guarantee a refined chromatic richness.

ICE and ICE Touch plates are made of glass and are characterised by a glossy finish

COLLECTION

# Satin Black

Black encapsulates everything. Black is night, **mystery, elegance.** Black highlights lines, frames, and traces boundaries. Black is sensual and eclectic. The **satin Black collection from Monochrome** is designed for those who want to explore the depths of stylistic personality, for those who want to seduce without screaming, for those who want to express strength and sophistication at the same time.

ICE and ICE Touch plates are made of glass and are characterised by a glossy finish



ONE

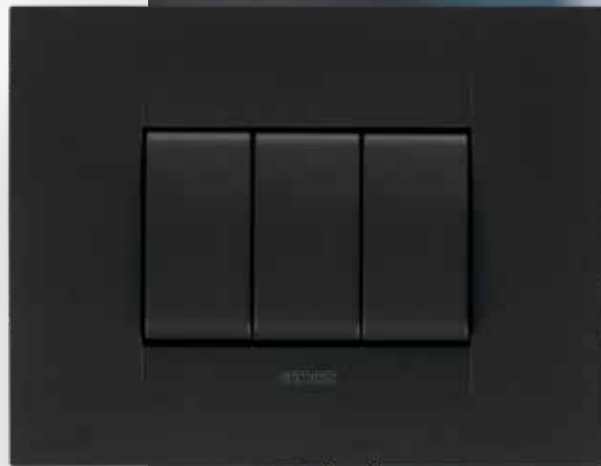

GEO



LUX



ICE



ICE TOUCH





COLLECTION

# Glossy White

The white page. The white frame. White gives space to dreams and opens the window of imagination, giving a sense of **freedom to our environments**. If you add the glossy surface to the white, these characteristics double. Brightness and reflections are added. The **glossy White collection from Monochrome** embodies the most modern spirit of decor, celebrating the lines of the future, connected to the theme of technology and digital.

ICE and ICE Touch plates are made of glass and are characterised by a glossy finish

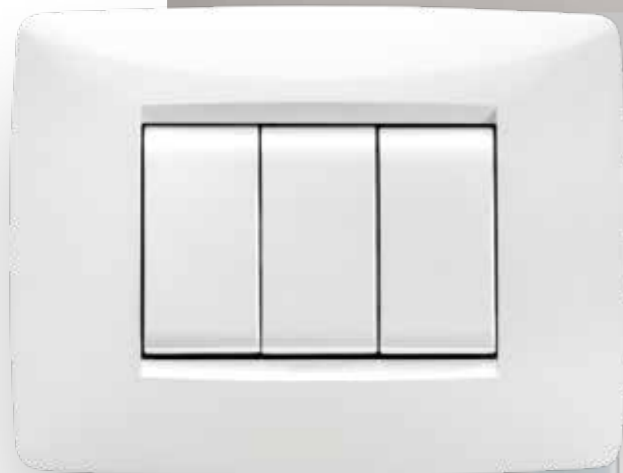

ONE

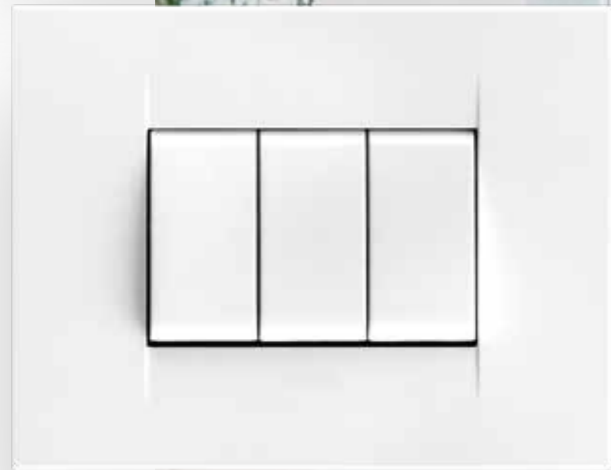

GEO



LUX

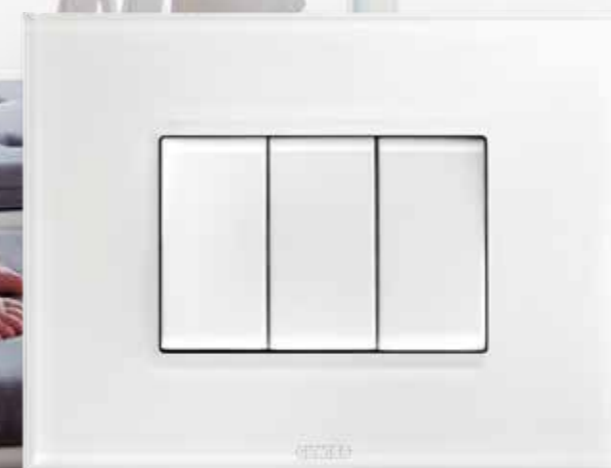

ICE



ICE TOUCH

COLLECTION

# Glossy Titanium

The great masters of design and architecture have made metal an essential element of contemporary living. Titanium, in particular, has become synonymous with **modernity and advanced technology**. The light and clean colour dialogues with very different decor and styles. The **glossy Titanium collection from Monochrome** embodies this multiple character, giving rhythm, and adding contrasts and nobility. Choosing it implies class and originality.

ICE and ICE Touch plates are made of glass and are characterised by a glossy finish

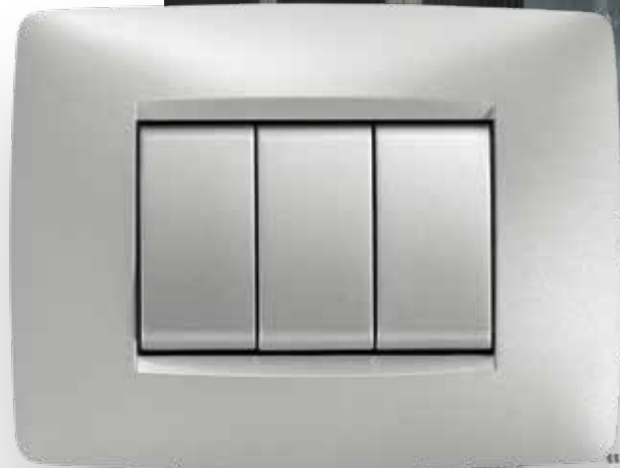

ONE

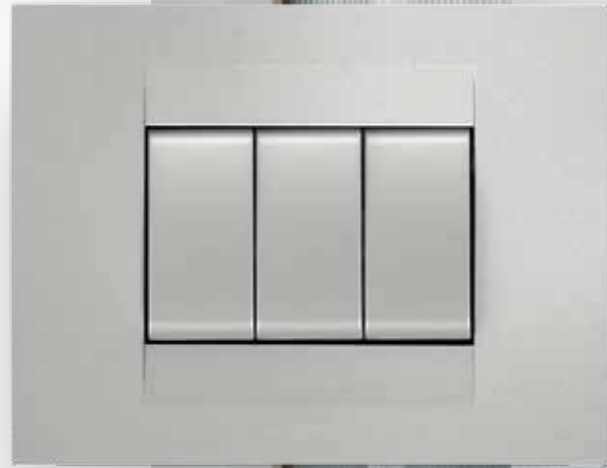

GEO



LUX



ICE



ICE TOUCH

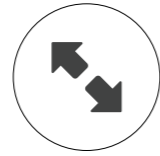

**SCALABLE**

CHORUS was created as a traditional wiring devices range, but with a few simple elements it has become **connected**, ideal for renovations or to update your home. The Gewiss **Smart Home** solution makes it even more complete and full of functionality.



Wireless solutions



THERMO ICE WIFI



Smart Gateway App



**INNOVATIVE**

The range offers a wide choice for building control: from the classic traditional control units to electronic soft-click push buttons, from touch devices to voice commands to the convenient App.

# CHORUS

CHORUS is Gewiss' innovative connected wiring devices range based on a wide range of modular devices, where technological solutions meet Italian design. In its continuous path of improvement and innovation, CHORUS combines sophisticated aesthetics, cutting-edge technologies and advanced functions, in synergy with each other, to respond to every contemporary living requirement.

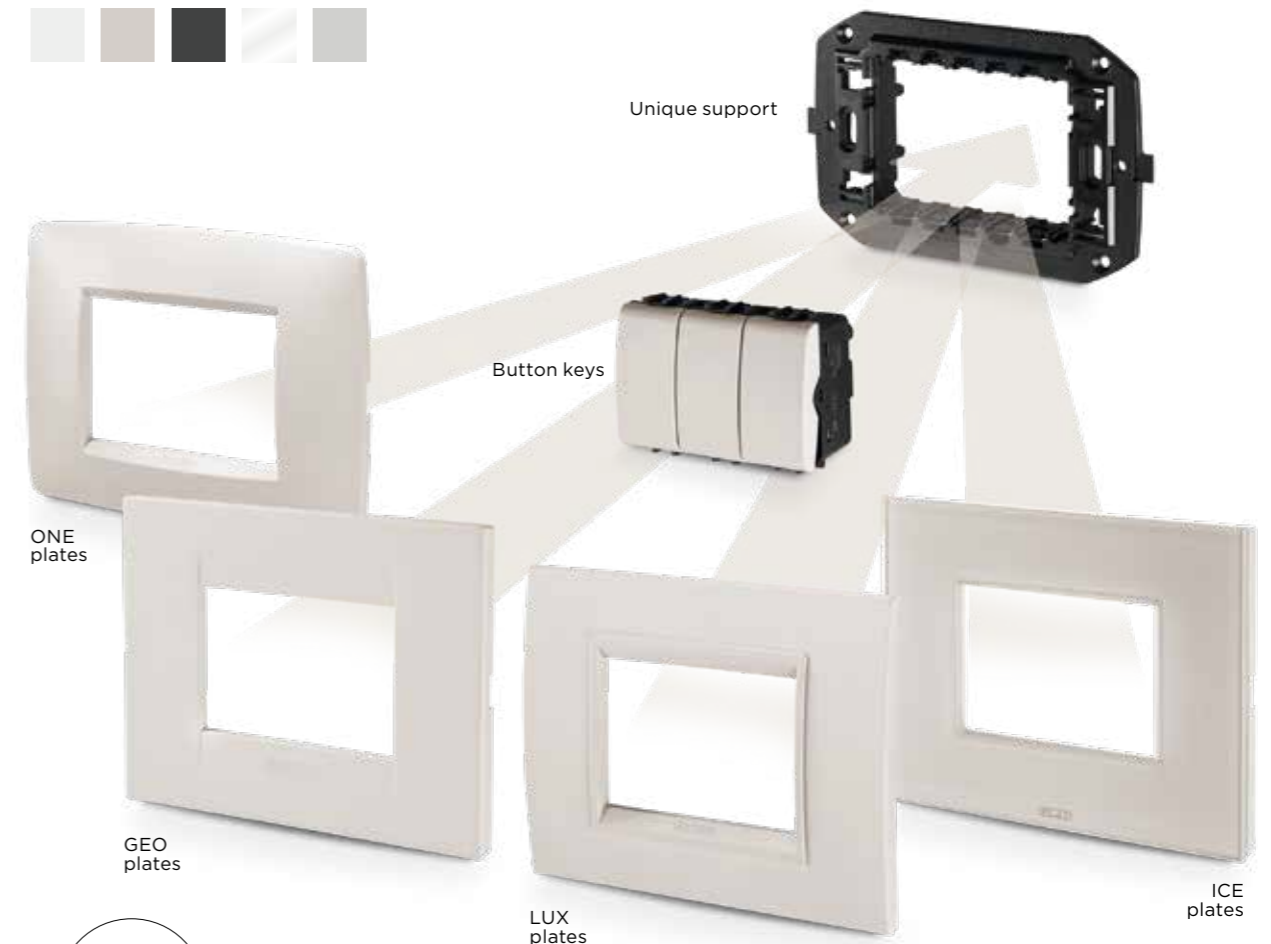

Unique support

Button keys

ONE plates

GEO plates

LUX plates

ICE plates



**FLEXIBLE**

With CHORUS you can choose over 80 combinations of colours, materials, finishes and shapes, always using the same support. A perfect mosaic of technology, elegance and performance that satisfies every taste and every need, whatever configuration is chosen and installed.

# Home is the place where we feel good

This is why each of us has the right to modify the term well-being according to our own standards. GEWISS residential solutions combine **technological excellence with ease of use**, always putting those who live in the home first.

A combination of solutions that make our domestic spaces comfortable, safe and efficient, with the appearance we like best. Technological solutions that evolve and always remain customisable to our needs and habits.

Every single need related to living (controlling shutters, lights, climate, energy, security systems) can be managed immediately through **the Smart Gateway App**, which allows us to access all functions of the house in a simple and intuitive way, both locally and remotely.

Think about the classic concept of the electrical system and then think about its evolution, thanks to the advent of increasingly intelligent technologies. GEWISS residential solutions combine the best parts of tradition with the excellence that we can expect from the future.



Smart Gateway



Smart Gateway App

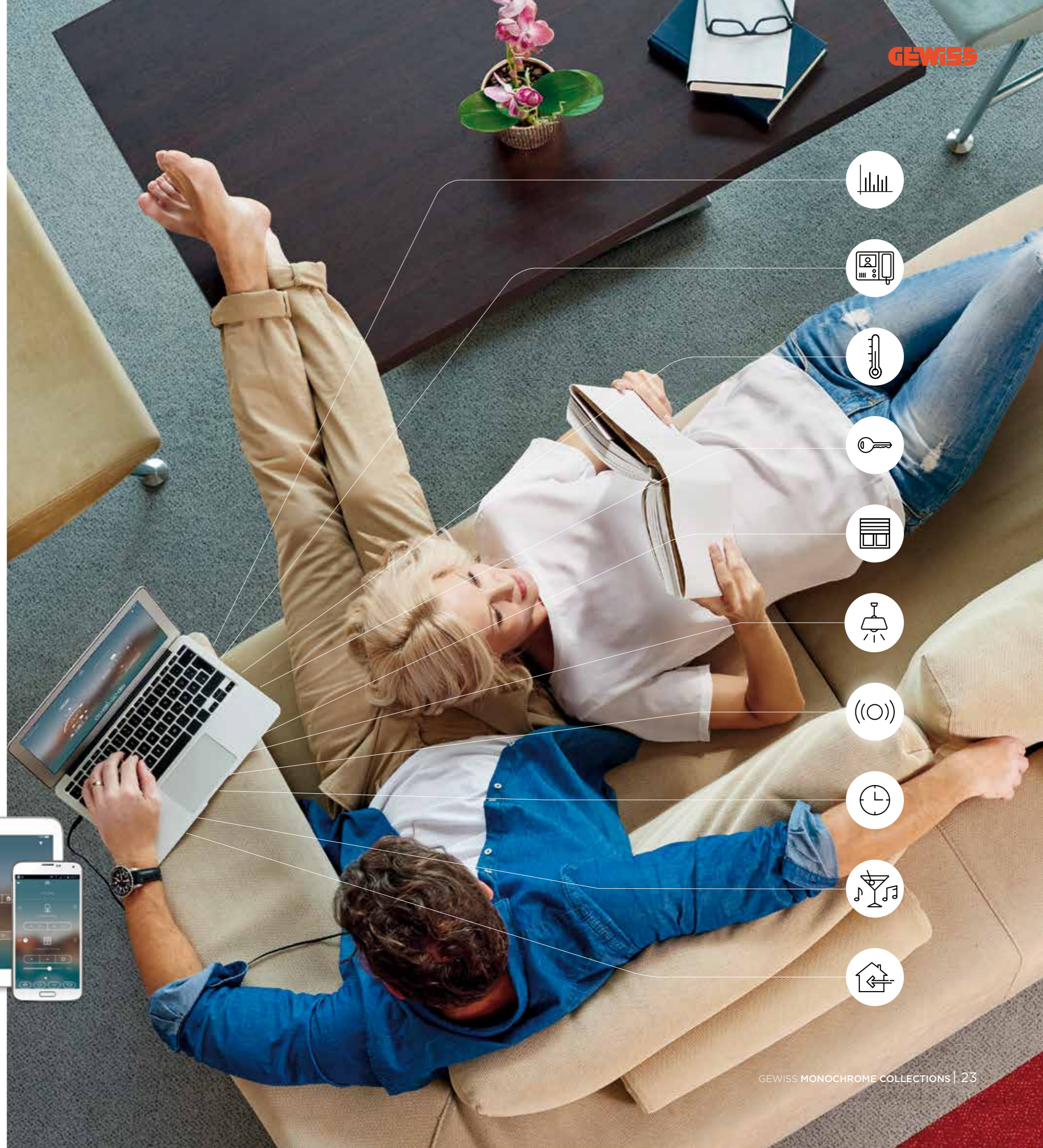

- 
- 
- 
- 
- 
- 
- 
- 
- 
-

- Feeling protected
- Feeling safe
- Feeling sustainable
- Feeling happy
- Feeling comfortable
- Feeling welcomed
- Feeling fulfilled

# The solutions for our home

A set of technologies that reconcile safety, energy savings, comfort and well-being requirements, and that simplify home life. **Smart Home** allows you to avoid waste and save on bills, but above all it makes the house cosy, comfortable and convenient to live in.



ONE style

GEO style

LUX style

ICE / ICE touch style

PAINTED TECHNOPOLYMER

PAINTED METAL

GLASS

SATIN WHITE COLLECTION

SATIN NATURAL BEIGE COLLECTION

SATIN BLACK COLLECTION

GLOSSY TITANIUM COLLECTION

GLOSSY WHITE COLLECTION



TECHNOPOLYMER

NOTE: ICE and ICE Touch plates are characterised by a glossy finish

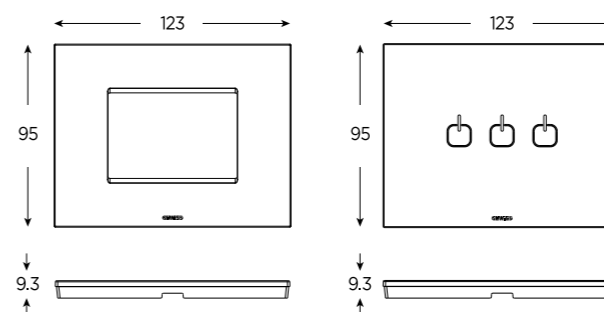
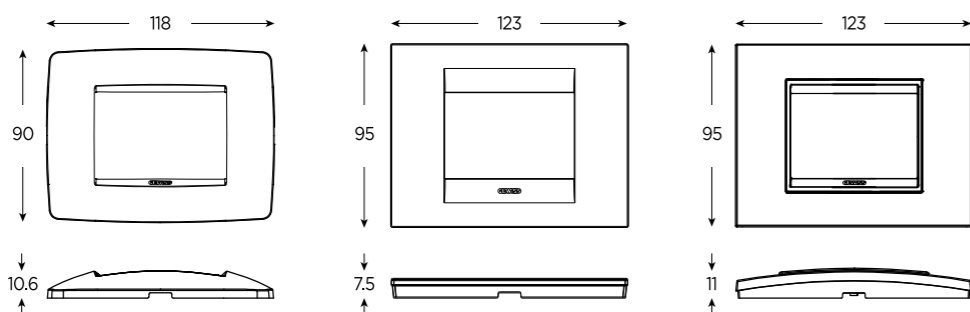

# CHORUS

## Monochrome Collections

**CHOOSE THE FINISH**  
 SATIN  
 GLOSSY

**CHOOSE THE COLOUR**  
 WHITE  
 NATURAL BEIGE  
 BLACK  
 TITANIUM

**CHOOSE YOUR FAVOURITE STYLE**  
 ICE / ICE TOUCH  
 LUX  
 GEO  
 ONE

COLLECTIONS

STYLES



# GEWISS

Visit [www.gewiss.com](http://www.gewiss.com) and follow us on:



## GEWISS S.p.A.

Registered Office: Via A. Volta, 1  
24069 CENATE SOTTO BG - Italy  
Tel. +39 035 946 111 - Fax. +39 035 945 222  
[gewiss@gewiss.com](mailto:gewiss@gewiss.com) - [www.gewiss.com](http://www.gewiss.com)

Single shareholder company - Bergamo Business Register/VAT/Tax Code (IT) 00385040167  
Economic and Administrative Index 107496 - Share Capital 60,000,000.00 EUR fully paid up

